

ISOMETRIC

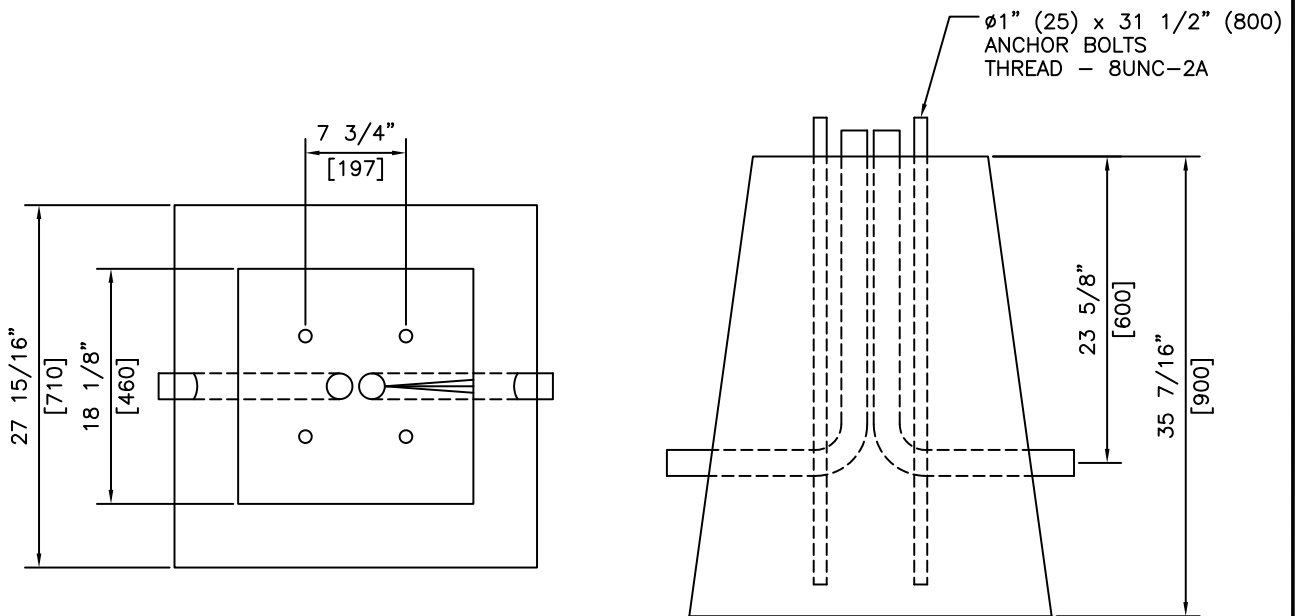

PLAN

ELEVATION

NOTES:

1) 27.6 MPa @ 28 DAYS

REVISED: FEB 22 2005



KON KAST

products (2005) Ltd.
"Committed To Quality And Service"

3440 UNIVERSITY WAY
KELOWNA B.C.
V1V 1V9
PH: (250)765-1423
FX: (250)765-0820

BY: PKR

DATE: FEB 22 05

SCALE: NTS

TYPE E-10

LIGHT STANDARD BASE

PEN STOCK #21-01-006

ITEM NO.

1047